

Rev.	ECN Number	Description	Date	Drawn	Checked	Approved

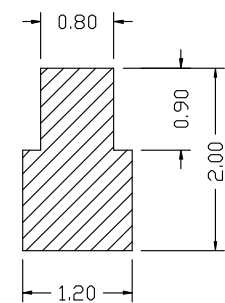

RECOMMENDED PCB LAYOUT
TOLERANCE ±0.05MM

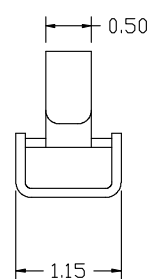
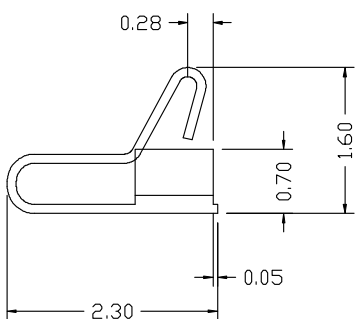
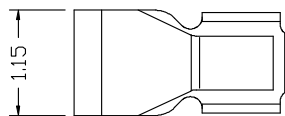
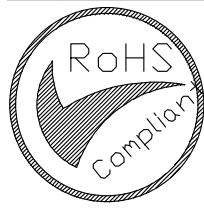
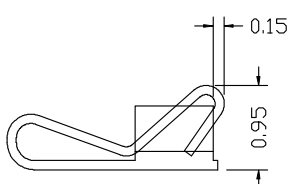

极限压下高度

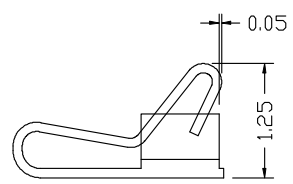

合理工作高度

NOTES:

- 1: 材质 SUS304
- 2: 表面处理 整体镀镍 50", 触点与焊盘位置镀金1u"
- 3: 性能:
接触电阻: 50mΩ MAX.
使用温度: -20° C~+65° C.
工作高度位置接触点压力0.5N
- 4: 包装.: 卷带包装

迪克松

GENERAL TOLERANCE	
XX. ±0.50	
X. ±0.35	X.° ±2.0°
.X ±0.25	.X° ±1.0°
.XX ±0.15	.XX° ±0.5°

SCALE: 1:1	
UNIT: mm	
SIZE: A4	

DRAWN: Chen	DATE: 2020. 6. 10
CHECK:	DATE:
APPROVE:	DATE:

DWG. NO.	PARTS NO.(INTENDED USE)
AS-053	

TITLE
(CUSTOMER DRAWING)
Antenna Spring,SMT, L2.3*W1.1*H1.6mm

REV. A
SHEET 1/1